

- Struttura in legno massiccio e multistrati con parti strutturali interne in metallo.
- Zoccolo in MDF laccato o metallo.
- Piano di appoggio perimetrale esterno a scelta in vetro verniciato, legno, marmo, tessuto o pelle.
- Seduta con molle in acciaio e cinghie elastiche.
- Sedili in poliuretano espanso e piuma d'oca.
- Cuscino schienale in piuma d'oca e ovatta siliconata
- Rivestimento struttura non sfoderabile.
- Disponibile nelle versioni schienale SOFT (cuscino schiena grande largo come sedile) o GLAMOUR (molteplici cuscini schiena di diverse misure).

- Frame in solid wood and plywood, with inner structural parts in metal.
- Base in lacquered MDF or in metal.
- Perimetral shelf in painted glass, wood, marble, fabric or leather.
- Steel springs and elastic belts for the structure below the seats.
- Polyurethane foam and goose feather seats.
- Back cushions in goose feather and fiber ball.
- Fixed upholstery for the structure (not removable).
- Available in the SOFT version (big back rectangular cushion wide as the seat), or in GLAMOUR version (several small back cushions in different sizes).

- Каркас выполнен из массива дерева и многослойной фанеры и с использованием металлического декора.
- Основание может быть выполнено из МДФ крашеного или из металла.
- Часть подлокотника может быть выполнена из крашеного стекла, дерева или мрамора, ткани или коже.
- Настил каркаса сиденья выполнен из стальных пружин и эластичных ремней.
- Подушки, на которых сидим выполнены с использованием эластичных ремней, стальных пружин.
- Подушки под спину выполнены из гусиного пуха и мебельной ваты.
- Чехлы на каркасе несъемные.
- Возможно выполнить в версии SOFT (в комплект входят большие прямоугольные подушки под спину) или в версии GLAMOUR (в комплект входит набор небольших подушек под спину разных размеров).

SOFT

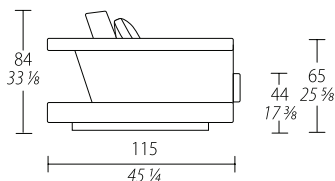
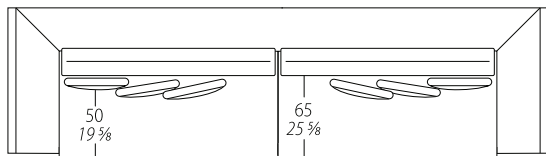

GLAMOUR

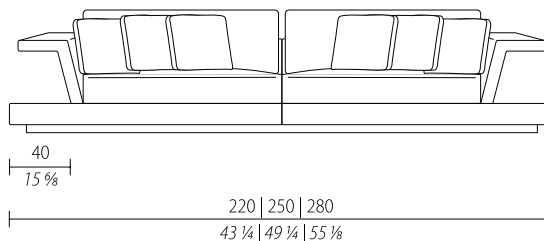
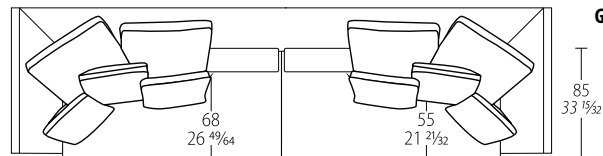

CENTRALI
ARM-LESS ELEMENTS
ЦЕНТРАЛЬНЫЙ МОДУЛЬ

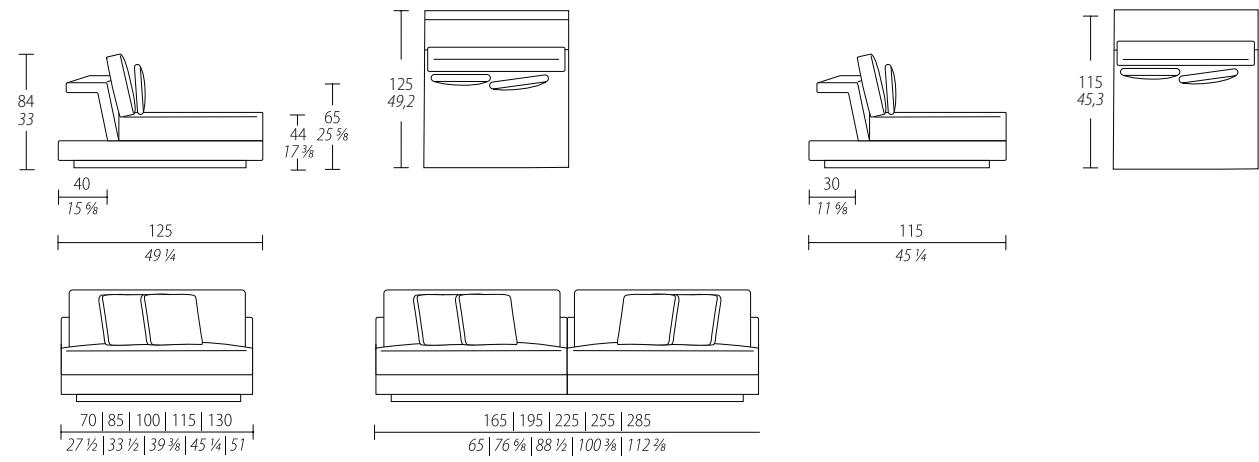

ELEMENTI AD ANGOLO
CORNER SECTIONAL ELEMENTS
УГЛОВОЙ МОДУЛЬ

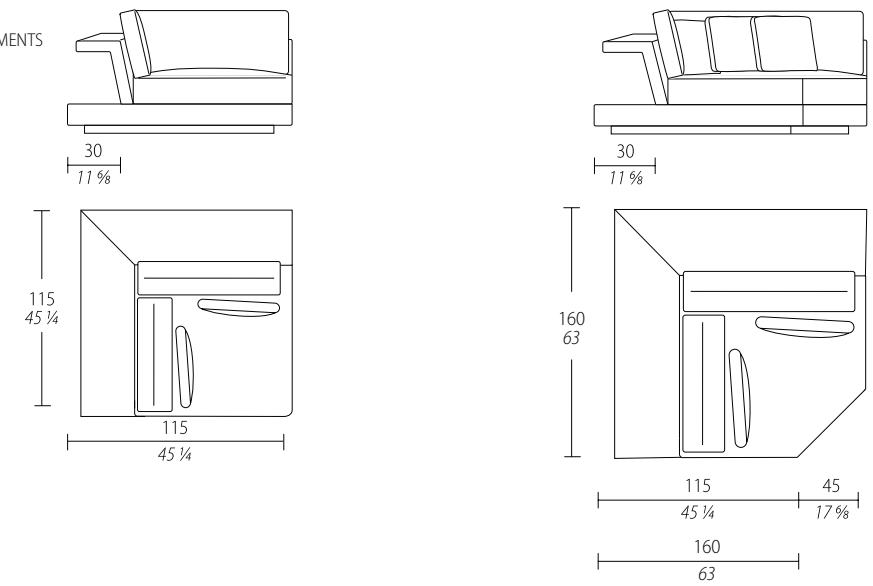

CENTRALE LUNGO
LONG ARM-LESS ELEMENT
ЦЕНТРАЛЬНЫЙ ЭЛЕМЕНТ
БОЛЬШЕГО РАЗМЕРА

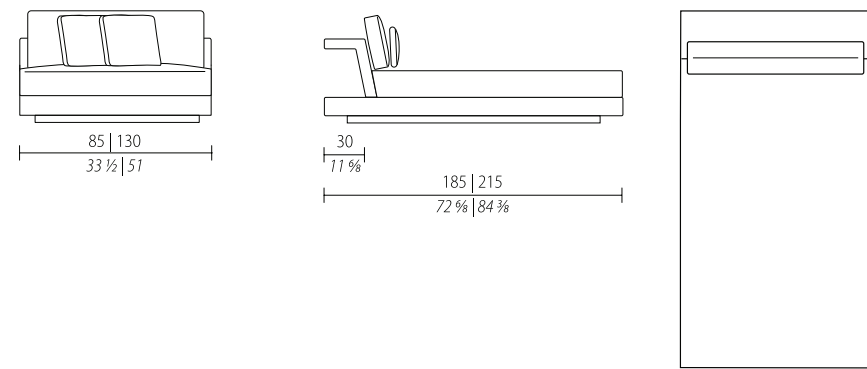

ISOLA
FREESTANDING ELEMENT
ОСТРОВНОЙ МОДУЛЬ

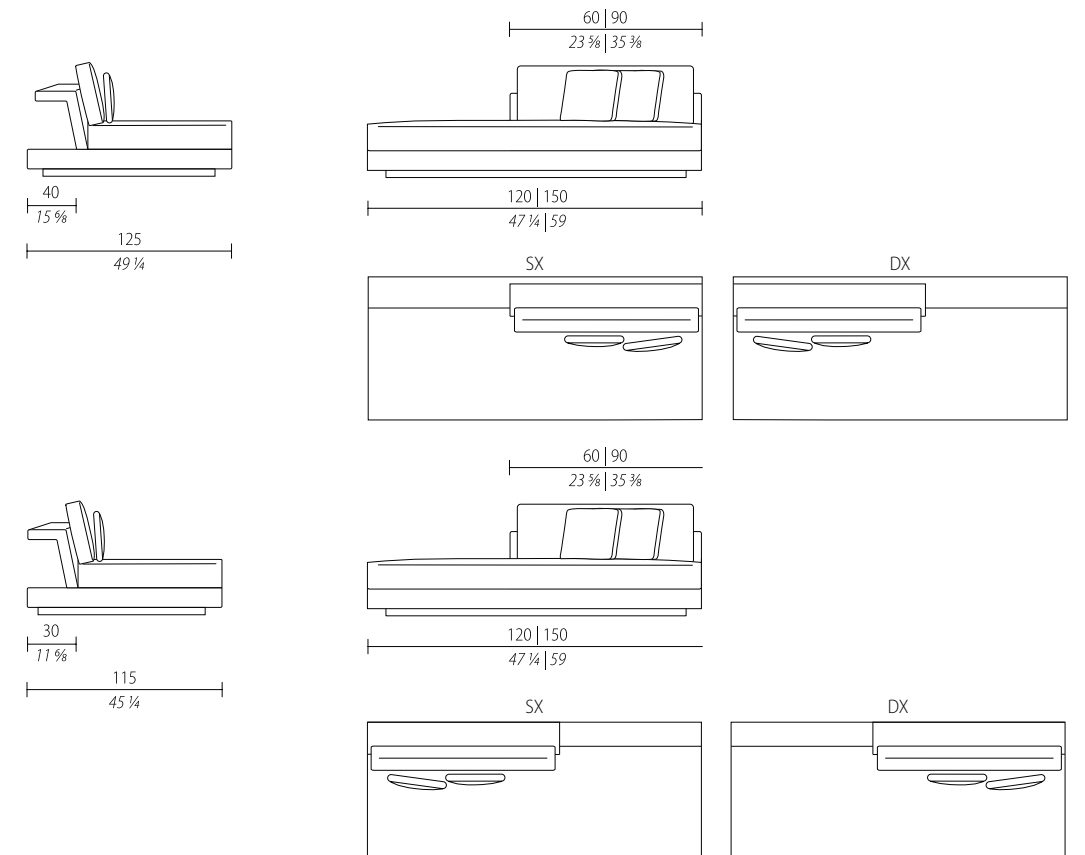

LATERALI
ONE-ARMREST ELEMENTS
БОКОВЫЕ МОДУЛИ

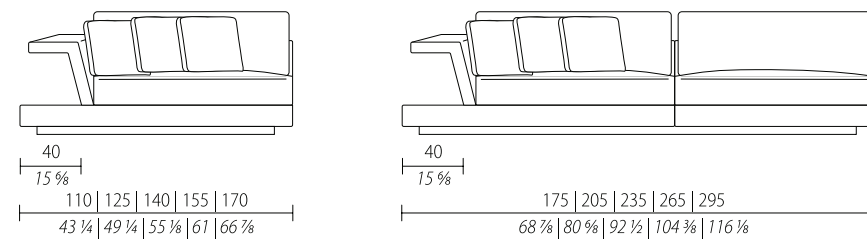

CHAISE LONGUE
CHAISE LONGUE
ШЕЗЛОНГ

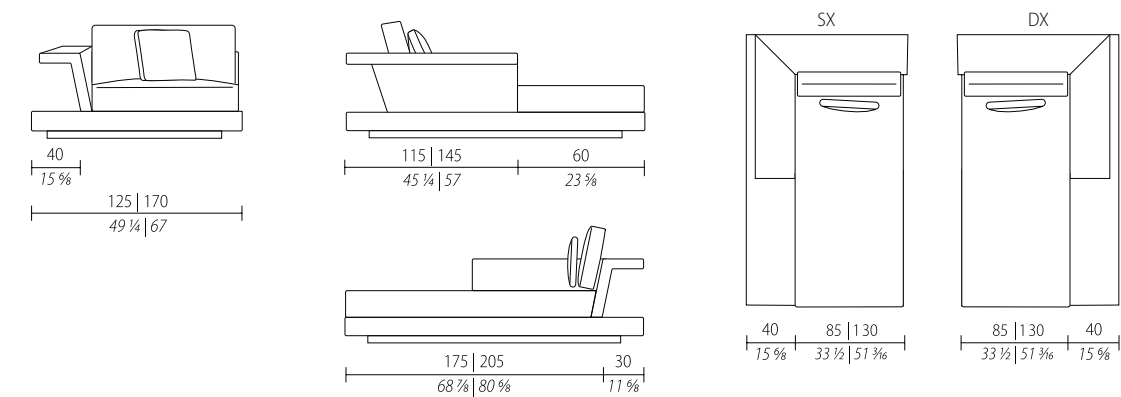

DAY BED
DAY BED
ЛЕЖАНКА

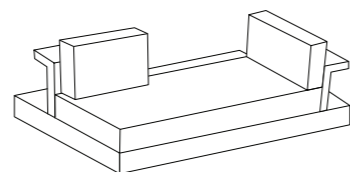
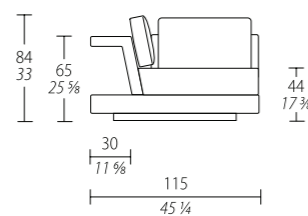
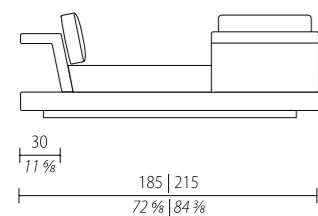
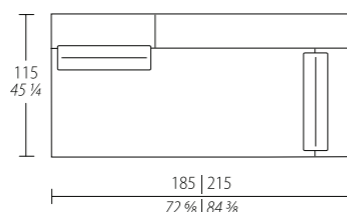
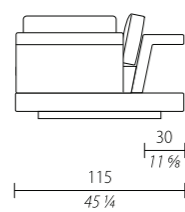
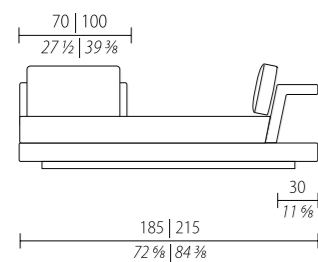

DX

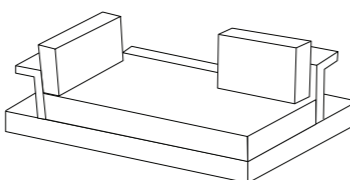
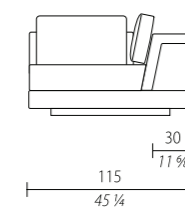
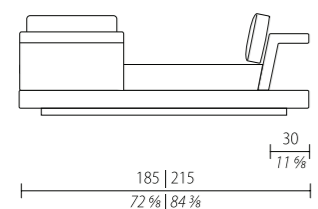
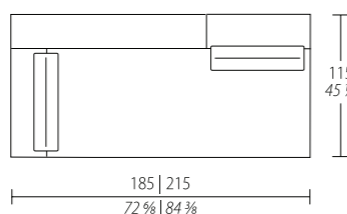
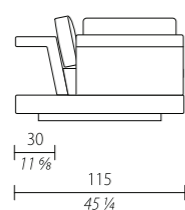
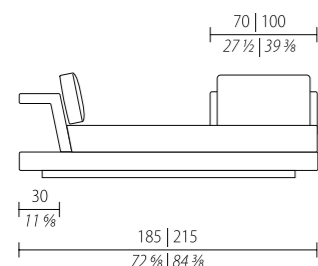

SX

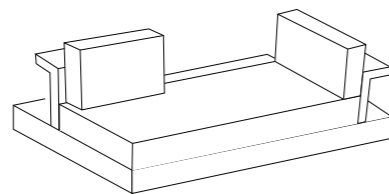
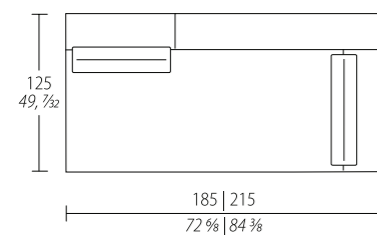
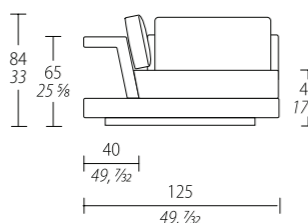
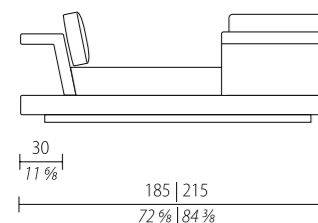
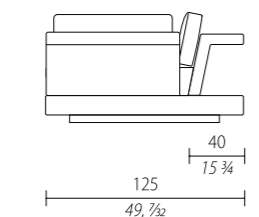
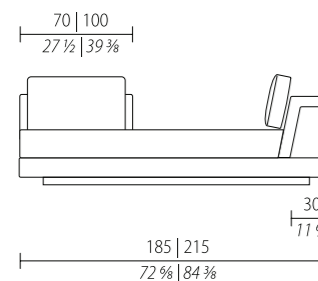

DX

DAY BED
DAY BED
ЛЕЖАНКА

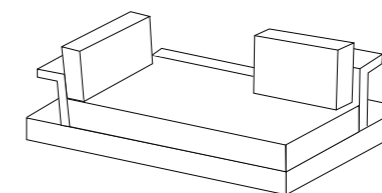
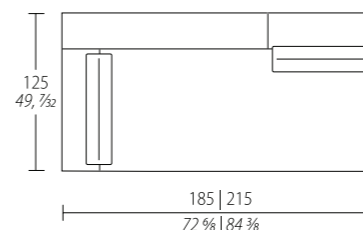
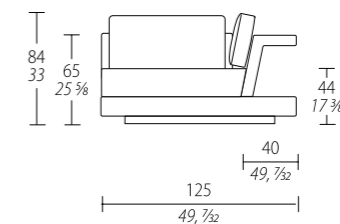
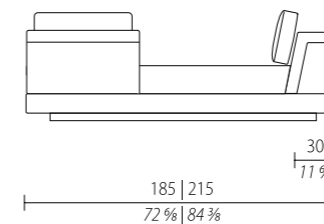
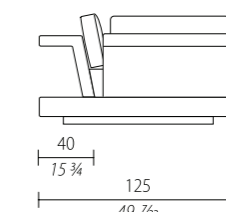
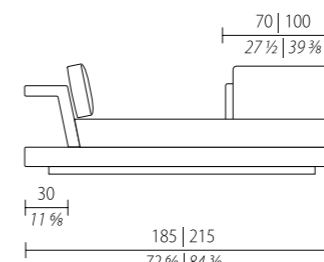

SX

POUF
FOOTSTOOL
ПУФ

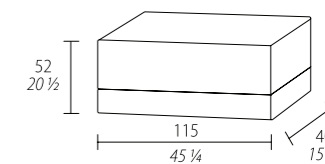
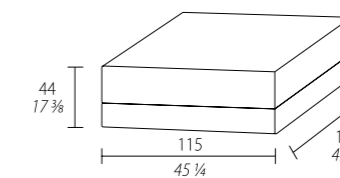
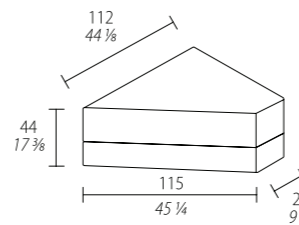

RIPIANO
SHELF
ПОЛКА

